

LP SERIES-General Purpose

LP4-4.5 (4V4.5AH)

Specification

| | | |
|----------------------------------|---|--------------------------------|
| Nominal Voltage | 4V | |
| Nominal Capacity(20HR) | 4.5AH | |
| Dimensions | Length | 52.5±1mm (2.07 inches) |
| | Width | 48±1mm (1.89 inches) |
| | Container Height | 94±1mm (3.70 inches) |
| | Total Height (with Terminal) | 100±2mm (3.94 inches) |
| Approx Weight | Approx 0.60 kg (1.32lbs) | |
| Terminal | T1 / T2 | |
| Container Material | ABS | |
| Rated Capacity | 4.50 AH/0.225A | (20hr , 1.80V/cell, 25°C/77°F) |
| | 4.19 AH/0.419A | (10hr, 1.80V/cell, 25°C/77°F) |
| | 3.78 AH/0.756A | (5hr, 1.75V/cell, 25°C/77°F) |
| | 3.30 AH/1.10A | (3hr, 1.75V/cell, 25°C/77°F) |
| | 2.73 AH/2.73A | (1hr, 1.60V/cell, 25°C/77°F) |
| Max. Discharge Current | 67.5A (5s) | |
| Internal Resistance | Approx 15mΩ | |
| Operating Temp. Range | Discharge | -15~50°C (5~122°F) |
| | Charge | 0~40°C (32~104°F) |
| | Storage | -15~40°C (5~104°F) |
| Nominal Operating Temp. Range | 25±3°C (77±5°F) | |
| Cycle Use | Initial Charging Current less than 1.35A. Voltage | |
| | 4.8V~5.0V at 25°C(77°F)Temp. Coefficient -10mV/°C | |
| Standby Use | No limit on Initial Charging Current Voltage | |
| | 4.5V~4.6V at 25°C(77°F)Temp. Coefficient -6mV/°C | |
| Capacity affected by Temperature | 40°C (104°F) | 103% |
| | 25°C (77°F) | 100% |
| | 0°C (32°F) | 86% |
| Self Discharge | Leoch LP series batteries may be stored for up to 6 months at 25°C(77°F) and then a freshening charge is required. For higher temperatures the time interval will be shorter. | |



Applications

- ◆ All purpose
- ◆ Uninterruptable Power Supply (UPS)
- ◆ Electric Power System (EPS)
- ◆ Emergency backup power supply
- ◆ Emergency light
- ◆ Railway signal
- ◆ Aircraft signal
- ◆ Alarm and security system
- ◆ Electronic apparatus and equipment
- ◆ Communication power supply
- ◆ DC power supply
- ◆ Auto control system



Constant Current Discharge (Amperes) at 25 °C (77°F)

| F.V/Time | 5min | 10min | 15min | 20min | 30min | 45min | 1h | 2h | 3h | 4h | 5h | 6h | 8h | 10h | 20h |
|------------|------|-------|-------|-------|-------|-------|------|------|------|-------|-------|-------|-------|-------|-------|
| 1.85V/cell | 8.64 | 6.02 | 4.97 | 4.31 | 3.46 | 2.66 | 2.17 | 1.33 | 1.01 | 0.831 | 0.706 | 0.611 | 0.486 | 0.404 | 0.223 |
| 1.80V/cell | 10.6 | 7.19 | 5.76 | 4.87 | 3.83 | 2.90 | 2.34 | 1.41 | 1.06 | 0.874 | 0.736 | 0.638 | 0.504 | 0.419 | 0.225 |
| 1.75V/cell | 12.6 | 8.13 | 6.35 | 5.31 | 4.09 | 3.08 | 2.46 | 1.47 | 1.10 | 0.901 | 0.756 | 0.654 | 0.518 | 0.427 | 0.227 |
| 1.70V/cell | 14.3 | 8.96 | 6.88 | 5.70 | 4.29 | 3.20 | 2.57 | 1.53 | 1.14 | 0.924 | 0.775 | 0.670 | 0.525 | 0.434 | 0.231 |
| 1.65V/cell | 15.7 | 9.64 | 7.27 | 5.98 | 4.47 | 3.32 | 2.67 | 1.58 | 1.17 | 0.943 | 0.792 | 0.683 | 0.534 | 0.440 | 0.234 |
| 1.60V/cell | 16.5 | 10.0 | 7.58 | 6.17 | 4.60 | 3.40 | 2.73 | 1.63 | 1.19 | 0.966 | 0.808 | 0.696 | 0.545 | 0.447 | 0.236 |

Constant Power Discharge (Watts/cell) at 25 °C (77°F)

| F.V/Time | 5min | 10min | 15min | 20min | 30min | 45min | 1h | 2h | 3h | 4h | 5h | 6h | 8h | 10h | 20h |
|------------|------|-------|-------|-------|-------|-------|------|------|------|------|------|------|-------|-------|-------|
| 1.85V/cell | 16.3 | 11.5 | 9.55 | 8.35 | 6.74 | 5.21 | 4.28 | 2.63 | 2.01 | 1.66 | 1.41 | 1.23 | 0.977 | 0.815 | 0.450 |
| 1.80V/cell | 19.8 | 13.6 | 11.0 | 9.37 | 7.41 | 5.65 | 4.58 | 2.78 | 2.10 | 1.73 | 1.46 | 1.27 | 1.007 | 0.838 | 0.452 |
| 1.75V/cell | 23.2 | 15.2 | 12.0 | 10.1 | 7.86 | 5.96 | 4.80 | 2.88 | 2.16 | 1.78 | 1.49 | 1.30 | 1.03 | 0.849 | 0.453 |
| 1.70V/cell | 26.0 | 16.6 | 12.9 | 10.8 | 8.20 | 6.16 | 4.97 | 2.98 | 2.22 | 1.81 | 1.52 | 1.32 | 1.04 | 0.858 | 0.459 |
| 1.65V/cell | 28.3 | 17.6 | 13.4 | 11.2 | 8.48 | 6.36 | 5.15 | 3.05 | 2.27 | 1.84 | 1.55 | 1.34 | 1.05 | 0.866 | 0.463 |
| 1.60V/cell | 29.2 | 18.1 | 13.9 | 11.4 | 8.62 | 6.44 | 5.22 | 3.13 | 2.31 | 1.87 | 1.57 | 1.36 | 1.07 | 0.876 | 0.464 |

Dimensions

T1 Terminal

Unit: mm [inches]

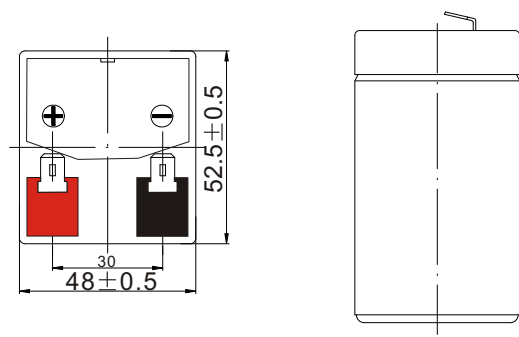
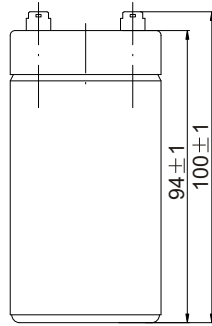
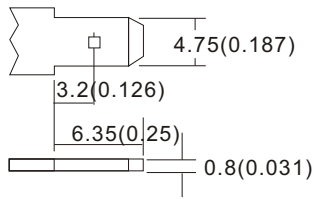

Discharge Characteristics

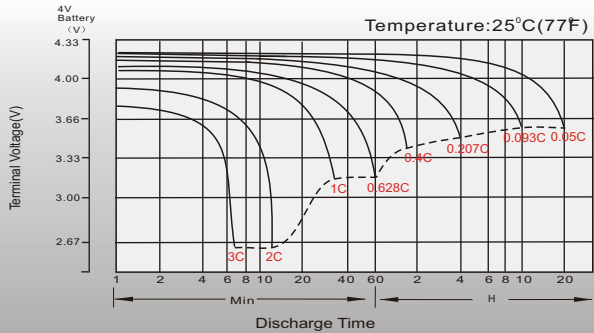

Float Charging Characteristics

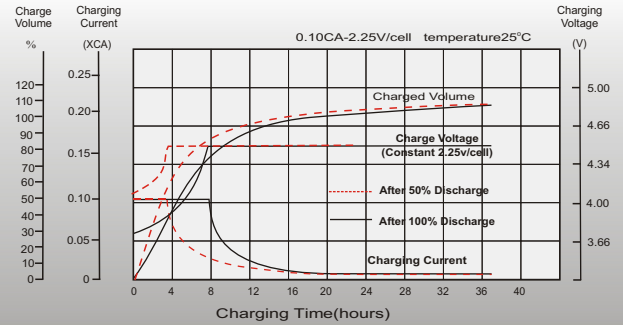

Temperature Effects in Relation to Battery Capacity

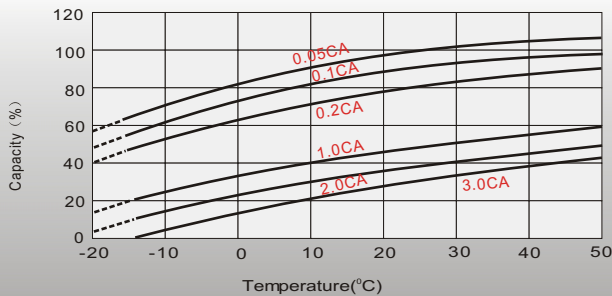

Effect of Temperature on Long Term Float Life

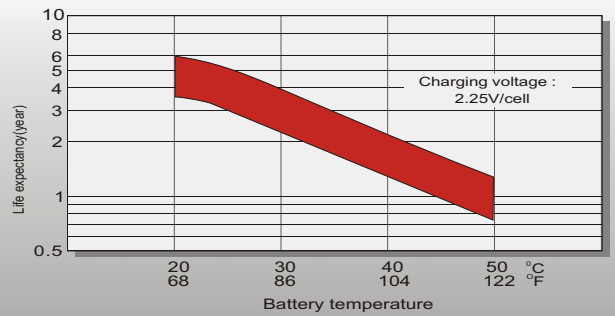

Cycle Life in Relation to Depth of Discharge

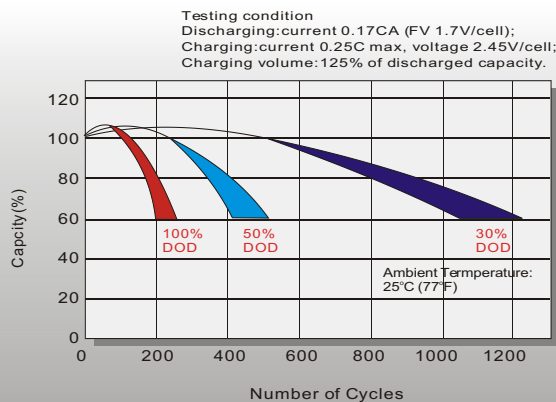

Self Discharge Characteristics

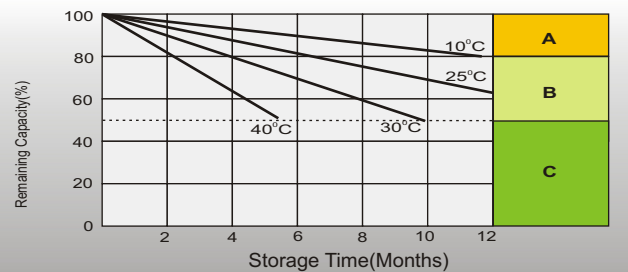

A No supplementary charge required (Carry out supplementary charge before use if 100% capacity is required.)

B Supplementary charge required before use. Optional charging way as below:
 1. Charged for above 3 days at limited current 0.25CA and constant voltage 2.25V/cell.
 2. Charged for above 20 hours at limited current 0.25CA and constant voltage 2.45V/cell.
 3. Charged for 8-10 hours at limited current 0.05CA.

C Supplementary charge may often fail to recover the capacity. The battery should never be left standing till this is reached.

Sales Office

China sales office:

Add: 5th Floor, Xinbaohui Bldg., Nanhai Blvd.,
 Nanshan, Shenzhen, China. 518052
 Tel: +86-755-86036060 (100 lines)
 Fax: +86-755-26067269
 E-mail: export@leoch.com
 Http://www.leoch.com

North America sales office:

Add: 19751 Descartes, Unit A,
 Foothill Ranch, CA 92610, USA
 Tel: 949-588-5853
 Fax: 949-588-5966
 E-mail: sales@leoch.us
 Http://www.leoch.us

Europe sales office:

Add: 9B Wheatstone Park, Waterwells
 Business Park, Gloucester, GL2 2AQ, UK.
 Tel: +44(0) 01452 729428
 Fax: +44 (0)1452-690125
 E-mail: Sales.Europe@leoch.com

Singapore sales office:

Add: No.53, Ubi Avenue 1, #03-21 Paya
 Ubi Industrial Park, Singapore 408934
 Tel: + 65 6841 6629
 E-mail: sales.sg@leoch.com

HongKong sales office:

Add: Unit 3910, 39/F, Cable TV Tower, No.9
 Hoi Shing Road, Tsuen Wan, NT, H.K
 Tel: +852 3578 6666
 E-mail: sales.hk@leoch.com