

LP SERIES-General Purpose

LP12-0.8 (12V0.8AH)

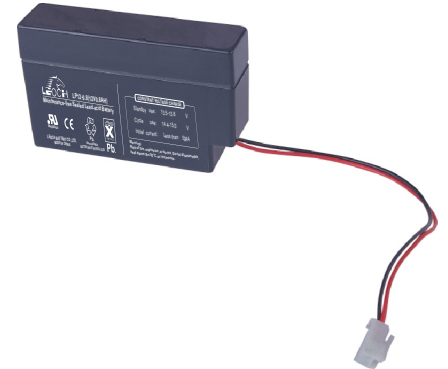

Specification

Nominal Voltage	12V	
Nominal Capacity(20HR)	0.8AH	
Dimensions	Length	96 ± 1mm (3.78 inches)
	Width	25 ± 1mm (0.98 inches)
	Container Height	62 ± 1mm (2.44 inches)
	Total Height (with Terminal)	62 ± 1mm (2.44 inches)
Approx Weight	Approx 0.35 kg (0.77lbs)	
Terminal	/	
Container Material	ABS	
Rated Capacity	0.80 AH/0.040A	(20hr, 1.80V/cell, 25°C/77°F)
	0.74 AH/0.074A	(10hr, 1.80V/cell, 25°C/77°F)
	0.67 AH/0.134A	(5hr, 1.75V/cell, 25°C/77°F)
	0.588 AH/0.196A	(3hr, 1.75V/cell, 25°C/77°F)
	0.486 AH/0.486A	(1hr, 1.60V/cell, 25°C/77°F)
Max. Discharge Current	12A (5s)	
Internal Resistance	Approx 150mΩ	
Operating Temp. Range	Discharge	-15 ~ 50°C (5 ~ 122°F)
	Charge	0 ~ 40°C (32 ~ 104°F)
	Storage	-15 ~ 40°C (5 ~ 104°F)
Nominal Operating Temp. Range	25 ± 3°C (77 ± 5°F)	
Cycle Use	Initial Charging Current less than 0.24A. Voltage	
	14.4V~15.0V at 25°C(77°F)Temp. Coefficient -30mV/°C	
Standby Use	No limit on Initial Charging Current Voltage	
	13.5V~13.8V at 25°C(77°F)Temp. Coefficient -20mV/°C	
Capacity affected by Temperature	40°C (104°F)	103%
	25°C (77°F)	100%
	0°C (32°F)	86%
Self Discharge	Leoch LP series batteries may be stored for up to 6 months at 25°C(77°F) and then a freshening charge is required. For higher temperatures the time interval will be shorter.	

Applications

- ◆ All purpose
- ◆ Uninterruptable Power Supply (UPS)
- ◆ Electric Power System (EPS)
- ◆ Emergency backup power supply
- ◆ Emergency light
- ◆ Railway signal
- ◆ Aircraft signal
- ◆ Alarm and security system
- ◆ Electronic apparatus and equipment
- ◆ Communication power supply
- ◆ DC power supply
- ◆ Auto control system



Constant Current Discharge (Amperes) at 25 °C (77°F)

F.V/Time	5min	10min	15min	20min	30min	45min	1h	2h	3h	4h	5h	6h	8h	10h	20h
1.85V/cell	1.54	1.07	0.883	0.766	0.614	0.473	0.386	0.236	0.180	0.148	0.125	0.109	0.086	0.072	0.040
1.80V/cell	1.89	1.28	1.02	0.866	0.680	0.515	0.416	0.251	0.189	0.155	0.131	0.113	0.090	0.074	0.040
1.75V/cell	2.24	1.44	1.13	0.943	0.726	0.547	0.438	0.262	0.196	0.160	0.134	0.116	0.092	0.076	0.040
1.70V/cell	2.54	1.59	1.22	1.01	0.763	0.569	0.456	0.272	0.202	0.164	0.138	0.119	0.093	0.077	0.041
1.65V/cell	2.80	1.71	1.29	1.06	0.795	0.591	0.475	0.280	0.207	0.168	0.141	0.121	0.095	0.078	0.042
1.60V/cell	2.94	1.79	1.35	1.10	0.818	0.604	0.486	0.289	0.212	0.172	0.144	0.124	0.097	0.080	0.042

Constant Power Discharge (Watts/cell) at 25 °C (77°F)

F.V/Time	5min	10min	15min	20min	30min	45min	1h	2h	3h	4h	5h	6h	8h	10h	20h
1.85V/cell	2.90	2.04	1.70	1.48	1.20	0.927	0.761	0.467	0.357	0.295	0.251	0.218	0.174	0.145	0.080
1.80V/cell	3.52	2.41	1.95	1.67	1.32	1.00	0.815	0.494	0.374	0.308	0.260	0.226	0.179	0.149	0.080
1.75V/cell	4.12	2.70	2.13	1.80	1.40	1.06	0.853	0.512	0.384	0.316	0.266	0.230	0.183	0.151	0.081
1.70V/cell	4.62	2.94	2.29	1.92	1.46	1.09	0.884	0.530	0.395	0.322	0.271	0.235	0.184	0.153	0.082
1.65V/cell	5.03	3.13	2.39	1.99	1.51	1.13	0.915	0.543	0.403	0.327	0.275	0.238	0.187	0.154	0.082
1.60V/cell	5.19	3.21	2.46	2.03	1.53	1.14	0.928	0.556	0.410	0.333	0.279	0.241	0.189	0.156	0.082

Dimensions

Terminal Unit: mm [inches]

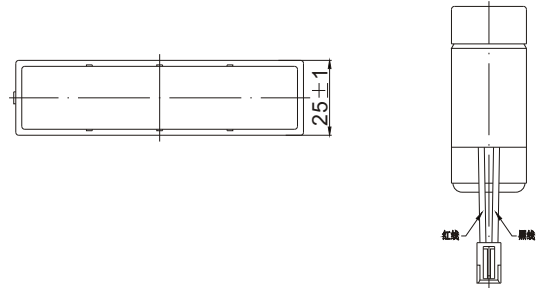
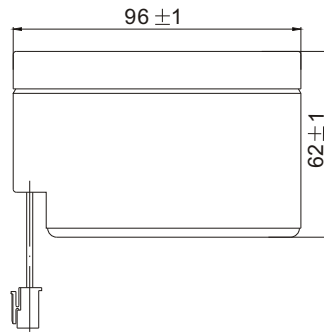
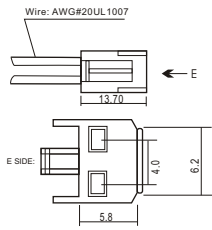

Discharge Characteristics

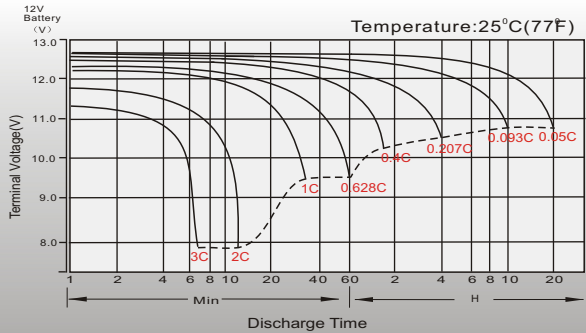

Float Charging Characteristics

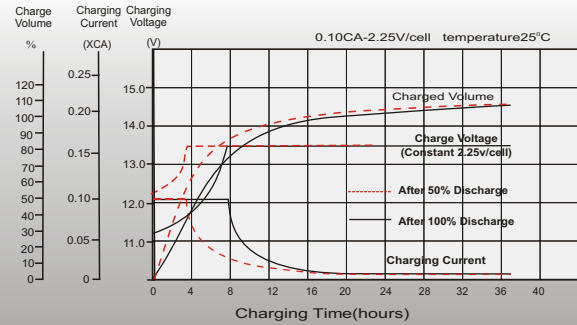

Temperature Effects in Relation to Battery Capacity

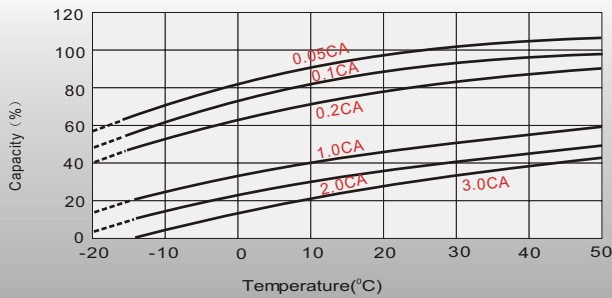

Effect of Temperature on Long Term Float Life

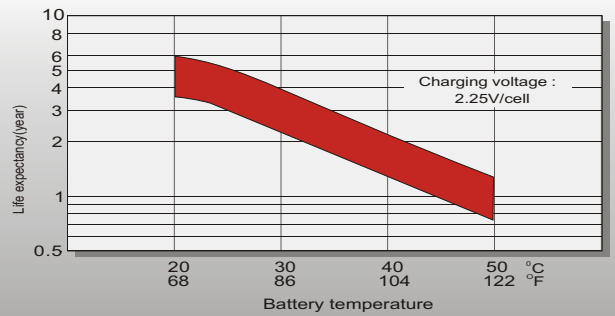

Cycle Life in Relation to Depth of Discharge

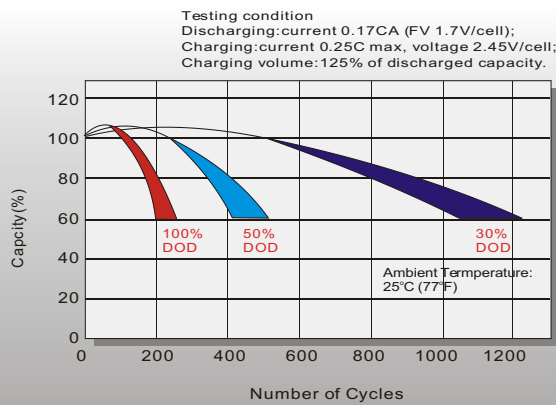

Self Discharge Characteristics

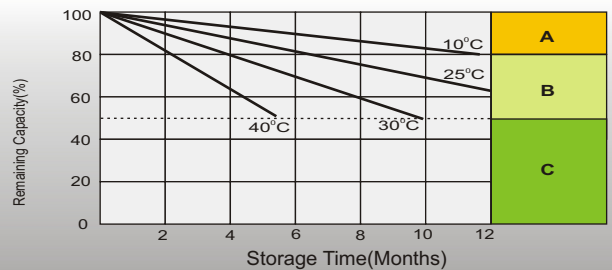

A No supplementary charge required
(Carry out supplementary charge before use if 100% capacity is required.)

B Supplementary charge required before use. Optional charging way as below:
1. Charged for above 3 days at limited current 0.25CA and constant voltage 2.25V/cell.
2. Charged for above 20 hours at limited current 0.25CA and constant voltage 2.45V/cell.
3. Charged for 8-10 hours at limited current 0.05CA.

C Supplementary charge may often fail to recover the capacity.
The battery should never be left standing till this is reached.

Sales Office

China sales office:

Add: 5th Floor, Xinbaohui Bldg., Nanhai Blvd.,
Nanshan, Shenzhen, China. 518052
Tel: +86-755-86036060 (100 lines)
Fax: +86-755-26067269
E-mail: export@leoch.com
Http://www.leoch.com

North America sales office:

Add: 19751 Descartes, Unit A,
Foothill Ranch, CA 92610, USA
Tel: 949-588-5853
Fax: 949-588-5966
E-mail: sales@leoch.us
Http://www.leoch.us

Europe sales office:

Add: 9B Wheatstone Park, Waterwells
Business Park, Gloucester, GL2 2AQ, UK.
Tel: +44(0) 01452 729428
Fax: +44 (0)1452-690125
E-mail: Sales.Europe@leoch.com

Singapore sales office:

Add: No.53, Ubi Avenue 1, #03-21 Paya
Ubi Industrial Park, Singapore 408934
Tel: + 65 6841 6629
E-mail: sales.sg@leoch.com

HongKong sales office:

Add: Unit 3910, 39/F, Cable TV Tower, No.9
Hoi Shing Road, Tsuen Wan, NT.H.K
Tel: +852 3578 6666
E-mail: sales.hk@leoch.com